

Mercmaster™ LED Series Luminaires

Enclosed and Gasketed Fixtures

NEC/CEC:
Class I, Division 2, Groups A, B, C, D
Class I, Zone 2, AEx nA IIC
Class II, Division 1, Group E, F, G
Class II, Division 2, Group F, G
Class III

NEC/CEC:
Type 3R, 4, 4X
IP66/67
Simultaneous Exposure
Suitable for Use in Wet Locations
Marine Outside Type (Salt Water)

ATEX/IECEX:
Zone 2 and 22
II 2 GD
IP66/67

Applications

- Enclosed and gasketed fixtures suitable for use in:
 - Marine and wet locations
 - A wide range of industrial, chemical processing and other areas where flammable gases and vapors are present
 - Areas of low clearance or low ceiling heights
 - Non-hazardous locations where severe weather conditions, excessive moisture, dirt, dust, corrosive atmosphere or high ambient temperatures are encountered
- Typical applications include:
 - Pulp and paper mills
 - Processing plants
 - Chemical plants
 - Oil refineries
 - Foundries
 - Manufacturing plants
 - Storage areas
 - Waste and sewage treatment
 - Parking garages
 - Other areas where dust, water, dirt and rough usage are a problem



Features

- Compact light weight low profile design is suited for low mounting heights.
- Modular design allows scores of fixture component combinations to meet installation needs. Uses same mounting hoods as Mercmaster III.
- Fixture housing and mounting hoods are copperfree cast aluminum with baked epoxy finish. All exposed hardware is stainless steel.
- Accommodates a wide range of voltages.
- Ambient temperatures:
 - 70 W to 100 W equivalent: -40 °C to +65 °C (-40 °F to +149 °F)
 - 150 W to 175 W equivalent: -40 °C to +55 °C (-40 °F to +131 °F)
 - 250 W equivalent: -40 °C to +50 °C (-40 °F to +122 °F)
 - 350 W equivalent: -40 °C to +50 °C (-40 °F to +122 °F)
 - 400 W equivalent: -40 °C to +55 °C (-40 °F to +131 °F)
- Electrical: 120-277 Vac, 50/60 Hz; 347-480 Vac, 50/60 Hz, Volts +/- 10%.
- Pole terminal block: 1 x 8-24 AWG; 1 x 0.75 to 6 mm² (0.0012 to 0.0093 in²).
- Hinge has high lip for added safety during installation and servicing. Hinge and bolt construction assures 360° compression at all points on ballast housing gasket for positive sealing. Swing away design of captive bolt and nut simplifies servicing.
- All Mercmaster mounting hoods have provision for easy field installation of fuses in fixtures (see Fixture Unit — Electrical Specification).
- NPT and metric threads standard.
- NEMA Type V light distribution is standard.
 - Type V distribution is required in areas where sufficient, evenly distributed light is necessary. It produces a circular distribution that has the same intensity at all angles.

- NEMA Type I light distribution is available as an option for select NEC/CEC certified fixtures.
 - Type I distribution is the perfect lighting for walkways, Type I distribution is perfect for lighting walkways, catwalks or anyplace where a narrow beam of light is required.
- For ATEX/IECEX rated fixtures, ballast bodies and mounting hoods must be purchased separately.

Standard Materials

- Mounting hoods and bodies: cast copperfree (4/10 of 1% max.) aluminum
- All hardware and catch assemblies: stainless steel
- Globe: polycarbonate

Standard Finishes

- Mounting hoods, bodies and guards: baked gray epoxy-clad finish, electrostatically applied for complete uniform protection

NEC/CEC Certifications and Compliances

- UL Standard: UL 50; UL 844; UL 1598; UL 1598A; UL 8750
- CSA Standard: C22.2 No 0; C22.2 No. 0.4; C22.2 No. 0.5; C22.2 No. 94; C22.2 No. 60529; C22.2 No. 137; C22.2 No. 250.0; C22.2 No. 60079; E60079-15
- ANSI/UL Standards: 60079-0; 60079-15
- ANSI/IEC Standards: 60529
- cCSAus Certified: 65182

Mercmaster™ LED Series Luminaires

Enclosed and Gasketed Fixtures

NEC/CEC:

Class I, Division 2, Groups A, B, C, D
Class I, Zone 2, AEx nA IIC
Class II, Division 1, Group E, F, G
Class II, Division 2, Group F, G
Class III

NEC/CEC:

Type 3R, 4, 4X
IP66/67
Simultaneous Exposure
Suitable for Use in Wet Locations
Marine Outside Type (Salt Water)

ATEX/IECEx:

Zone 2 and 22
II 2 GD
IP66/67

ATEX/IECEx Certification and Compliances

- ATEX
 - Gas: Zone 2
 - Conforming to ATEX 94/9/CE: Ⓜ II 3 G
 - Type of Protection: Ex nA IIC Gc
 - Temperature class:
 - 70 W and 100 W equivalent: T4 [+40 °C (+104 °F)], T4 [+55 °C (+131 °F)], T3 [+65 °C (+149 °F)]
 - 150 W to 175 W equivalent: T4 [+40 °C (+104 °F)], T4 [+55 °C (+131 °F)]
 - 250 W equivalent: T4 [+40 °C (+104 °F)], T4 [+50 °C (+122 °F)]
 - Dust: Zone 22
 - Conforming to ATEX 94/9/CE: Ⓜ II 3 D
 - Type of Protection: Ex tc IIIc Dc
 - Surface Temperature:
 - 70 W and 175 W equivalent: T92 °C (T197.6 °F)
 - 250 W equivalent: T79 °C (T174.2 °F)
 - Ambient Temperature:
 - 70 W and 100 W equivalent: -40 °C to +65 °C (-40 °F to +149 °F)
 - 150 W to 175 W equivalent: -40 °C to +55 °C (-40 °F to +131 °F)
 - 250 W equivalent: -40 °C to +50 °C (-40 °F to 122 °F)
 - ATEX Certificate: LCIE 11 ATEX 1008, LCIE 14 ATEX 3063
 - IECEx Certificate: IECEx LCI 11.0058
 - Index of Protection according EN/IEC 60529: IP66
- IECEx
 - Gas: Zone 2
 - Type of Protection: Ex nA IIC Gc
 - Temperature class:
 - 70 W to 175 W equivalent: T4 [+40 °C (+104 °F)], T4 [+55 °C (+131 °F)]
 - 250 W equivalent: T4 [+40 °C (+104 °F)], T4 [+50 °C (+122 °F)]
 - Dust: Zone 22
 - Type of Protection: Ex tc IIIc Dc
 - Surface Temperature:
 - 70 W and 175 W equivalent: T92 °C (198 °F)
 - 250 W equivalent: T79 °C (198 °F)
 - Ambient Temperature:
 - 70 W and 175 W equivalent: -40 °C to +55 °C (-40 °F to +131 °F)
 - 250 W equivalent: -40 °C to +50 °C (-40 °F to +122 °F)
 - IECEx Certificate: IECEx LCI 11.0058
 - Index of Protection according EN/IEC 60529: IP66

EURASEC Certification

- EURASEC N° TC RU C-FR.Г505.B.00912

Other Certification

- INMETRO Certificate: BVC12.1522 ①

NEC/CEC Related Products

- NEC, Class I, Division 2 photocells for classified use are available, see *PCD2 Series*.
- Mounting hoods with photocontrols are not rated IP66/67, Type 4X or Marine Outside Type (Salt Water).

DesignLights™ Consortium (for the following models)

- MLEDN15
- MLEDN17
- MLEDN25
- MLEDN35
- MLEDN40

① Inmetro certification available on special request only. Contact your local sales representative for more information.

Mercmaster™ LED Series Luminaires

Enclosed and Gasketed Fixtures

NEC/CEC:

Class I, Division 2, Groups A, B, C, D
Class I, Zone 2, AEx nA IIC
Class II, Division 1, Group E, F, G
Class II, Division 2, Group F, G
Class III

NEC/CEC:

Type 3R, 4, 4X
IP66/67
Simultaneous Exposure
Suitable for Use in Wet Locations
Marine Outside Type (Salt Water)

ATEX/IECEX:

Zone 2 and 22
II 2 GD
IP66/67

Illustrated Features



Heatsink

Reliable heat transfer via the cast, epoxy powder coat aluminum body. Provides maximum heat dissipation from the LED assembly to the outside environment.

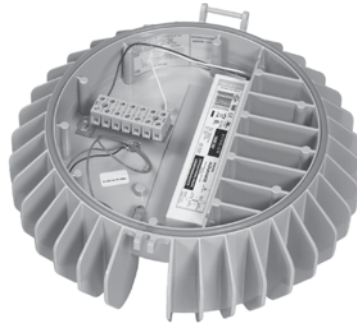

Driver Assembly

Utilizing non-sparking components avoiding the ignition of gases or vapors that may be present (nA).

Modular Plug between LED and driver.

Terminal Blocks (Zone 2)

A seven-point terminal block is provided to facilitate wiring. Terminal block accommodates wire size ranging from #8 to #24AWG, 0.75 to 6 mm² (0.0012 to 0.0093 in²)



LED Chamber

Protected by polycarbonate lens, allows for easy maintenance access.

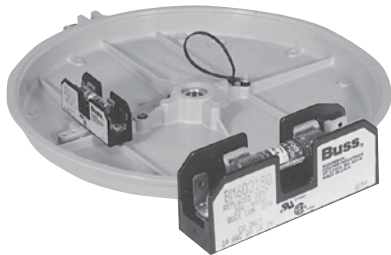

Fuses ①

Two screws secure fuse kit to mounting boss in any Mercmaster mounting hood. Fuse included.

Photocell ①

Available for all fixtures except cone and ceiling mount. Installs through knock-out in mounting hood. Provides continuous ON-OFF dusk-to-dawn control.

Epoxy Finish

Ballast housing, hoods and guards are copperfree aluminum with epoxy powder coat finish.

Electrical Protection

Ground wire provided to bond mounting hood to ballast housing.

Safety

Rounded heatsink edges prevent possible injury during installation.

"Safety" High Hinge

Extra-high hinge provides additional protection against accidental ballast housing disengagement during installation or maintenance.

Stainless Steel Latch Assembly

Captive, stainless steel latch assembly bolt and nut closes securely, resists attack of corrosive atmospheres. Swing-away design simplifies servicing.



Cooler Operating Cone Hood

Larger sloped surface sheds dusts, dirt and combustible fibers providing better heat dissipation.

Mounting Hood and Globe Gaskets

Silicone rubber gaskets seals out moisture, dirt and dust. Stays flexible, withstands high temperatures. Closure design assures uniform gasket compression.



① Fuses and photocells are available on the NEC/CEC versions only. Not for use in ATEX/IEC.

Mercmaster™ LED Series Luminaires

Enclosed and Gasketed Fixtures

NEC/CEC:

Class I, Division 2, Groups A, B, C, D
 Class I, Zone 2, AEx nA IIC
 Class II, Division 1, Group E, F, G
 Class II, Division 2, Group F, G
 Class III

NEC/CEC:

Type 3R, 4, 4X
 IP66/67
 Simultaneous Exposure
 Suitable for Use in Wet Locations
 Marine Outside Type (Salt Water)

ATEX/IECEX:

Zone 2 and 22
 11 2 GD
 IP66/67

Mercmaster LED Family Tree

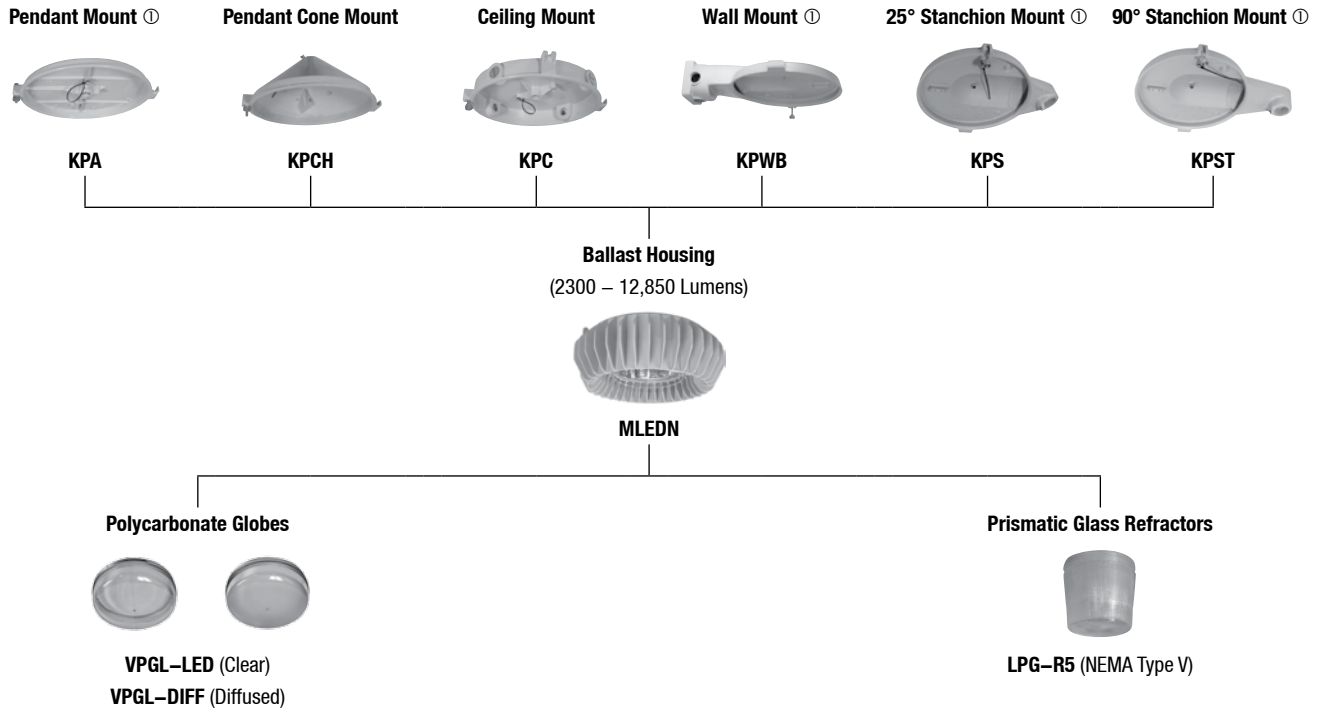

LED/AREA: NEC/CEC, ATEX/IECEX ENCLOSED AND GASKETED

① Mounting hood with a 120 V or 208-277 V factory installed photocell is available.

Mercmaster™ LED Series Luminaires

Enclosed and Gasketed Fixtures

NEC/CEC:

Class I, Division 2, Groups A, B, C, D
 Class I, Zone 2, AEx nA IIC
 Class II, Division 1, Group E, F, G
 Class II, Division 2, Group F, G
 Class III

NEC/CEC:

Type 3R, 4, 4X
 IP66/67
 Simultaneous Exposure
 Suitable for Use in Wet Locations
 Marine Outside Type (Salt Water)

ATEX/IECEx:

Zone 2 and 22
 Ⓢ II 2 GD
 IP66/67

Order using catalog numbering guides below or select catalog number from tables on following pages.

Catalog Numbering Guide — NEC/CEC Certified Mercmaster LED

MLEDN	A	17	2	P	5	BU	H1
MLEDN - NEC/CEC Certified Mercmaster LED Series		Light Level Equivalent: 70 - 70 W HPS/PSMH 10 - 100 W HPS/PSMH 15 - 150 W HPS/PSMH 17 - 175 W PSMH ② 25 - 250 W HPS/PSMH 35 - 350 W PSMH ⑤ 40 - 400 W HPS/PSMH ⑥		Optical Assembly: P - Polycarbonate Globe J - Prismatic Glass Refractor		Voltage: BU - Universal Voltages 120-277 Vac, 50/60 Hz BH - 347-480 Vac, 50/60 Hz	
	Mounting: A - Pendant C - Ceiling ① D - Pendant Cone R - 90° Stanchion S - 25° Stanchion W - Wall		Hub Size: 2 - 3/4" NPT 3 - 1" NPT 4 - 1-1/4" NPT stanchion 5 - 1-1/2" NPT stanchion 6 - Metric M20		Light Distribution: 1 - NEMA Type I Elliptical (100 W HPS and 175 W PSMH Only) 5 - NEMA Type V Symmetrical		Options: D - Diffused Globe F - Fusing H1 - Photocontrol 120 V ③ H2 - Photocontrol 208 V ③ H3 - Photocontrol 240 V ③ H4 - Photocontrol 277 V ③

Catalog Numbering Guide — ATEX/IECEx Certified Mercmaster LED ④

MLEDNA	—	17	—	P	5	BU	D
MLEDNA - ATEX/IECEx Certified Mercmaster LED Series		Light Level Equivalent: 70 - 70 W HPS/PSMH 10 - 100 W HPS/PSMH 15 - 150 W HPS/PSMH 17 - 175 W PSMH ② 25 - 250 W HPS/PSMH		Optical Assembly: P - Polycarbonate Globe		Voltage: BU - Universal Voltages 120-277 Vac, 50/60 Hz	
	Mounting: ATEX/IECEx version is not available as a complete fixture (not sold with mounting hood)		Hub Size: ATEX/IECEx version is not available as a complete fixture (hub size does not apply)		Light Distribution: 5 - NEMA Type V Symmetrical		Options: D - Diffused Globe

① Ceiling mount luminaires are not designed to use the PCD2 photocontrol. Ceiling mounts must use an FS/FD box with a photocontrol. Contact your local sales representative for more information.

② 175 W Pulse Start Metal Halide only. Does not have a High Pressure Sodium equivalent.

③ Luminaires with photocontrol are not rated IP66/67 or marine outside type (salt water).

④ For ATEX/IECEx rated fixtures, ballast bodies and mounting hoods must be purchased separately.

⑤ Available for use with the BH voltage only (347-480 Vac, 50/60 Hz).

⑥ Available for use with the BU voltage only (120-277 Vac, 50/60 Hz).

Mercmaster™ LED Series Luminaires

Enclosed and Gasketed Fixtures

NEC/CEC:
 Class I, Division 2, Groups A, B, C, D
 Class I, Zone 2, AEx nA IIC
 Class II, Division 1, Group E, F, G
 Class II, Division 2, Group F, G
 Class III

NEC/CEC:
 Type 3R, 4, 4X
 IP66/67
 Simultaneous Exposure
 Suitable for Use in Wet Locations
 Marine Outside Type (Salt Water)

ATEX/IECEX:
 Zone 2 and 22
 Ⓢ II 2 GD
 IP66/67

Technical Data

Lamp		Ambient Temperature °C (°F)	Supply Wire Temperature °C (°F)	NEC/CEC				ATEX/IECEX			
Light Level Equivalent to HID	Type			Class I, Division 2 ①	Gas Groups	Class I, Zone 2, AEx nA IIC, Ex nA IIC	Class II, Division 1 and 2 ②	Dust Groups	Gas/Dust Simultaneous ① Class I, Division 2/ Class II, Division 1	Gas Ex II 3G ① nA	Dust Ex II 3D ② Ex tc IIIC
70 Watt NEMA Type V	LED	40 (104)	60 (140)	T4A	A, B, C, D	T4	T6	E, F, G	T4	T4	T92°C (T197.6°F) Dc
		55 (131)	75 (167)	T4		T4	T6		T4		
		65 (149)	90 (194)	T3C		T3	T6		T3C		
100 Watt NEMA Type V	LED	40 (104)	60 (140)	T4A	A, B, C, D	T4	T6	E, F, G	T4	T4	T92°C (T197.6°F) Dc
		55 (131)	75 (167)	T4		T4	T6		T4		
		65 (149)	90 (194)	T3C		T3	T6		T3C		
100 Watt NEMA Type I ③	LED	40 (104)	60 (140)	T4	A, B, C, D	T4	T5	E, F, G	T4	—	—
		55 (31)	75 (167)	T3C		T3	T5		T3C		
		65 (143)	90 (194)	T3C		T3	T4A		T3C		
150 Watt NEMA Type V	LED	40 (104)	60 (140)	T4A	A, B, C, D	T4	T6	E, F, G	T4	T6	T92°C (T197.6°F) Dc IP66
		55 (131)	75 (167)	T4		T4	T6		T4		
175 Watt NEMA Type V	LED	40 (104)	60 (140)	T4A	A, B, C, D	T4	T6	E, F, G	T4	T6	T92°C (T197.6°F) Dc IP66
		55 (131)	75 (167)	T4		T4	T6		T4		
175 Watt NEMA Type I ③	LED	40 (104)	60 (140)	T4	A, B, C, D	T4	T5	E, F, G	T4	—	—
		55 (131)	75 (167)	T3C		T3	T5		T3C		
250 Watt NEMA Type V ③	LED	40 (104)	60 (140)	T4A	A, B, C, D	T4	T6	E, F, G	T4A	T4	T79°C (T174.2°F) Dc
		50 (122)	75 (167)	T4		T4	T6		T4		
350 Watt NEMA Type V ③	LED	40 (104)	75 (167)	T3A	A, B, C, D	T3	—	—	—	—	—
		50 (122)	75 (167)	T3		T3	—		—		
400 Watt NEMA Type V ③	LED	40 (104)	75 (167)	T3A	A, B, C, D	T3	—	—	—	—	—
		55 (131)	75 (167)	T3		T3	—		—		

“T” Numbers Represent the Maximum Internal Temperature ① or Maximum Surface Temperature ②

“T” #	NEC/CEC															
	T1	350	325	T2	T2A	T2B	T2C	T2D	T3	T3A	T3B	T3C	T4	T4A	T5	T6
Temp. Range °C (°F)	351-450 (664-842)	326-350 (619-662)	301-325 (574-617)	281-300 (538-572)	261-280 (502-536)	231-260 (448-500)	216-230 (421-446)	201-215 (394-419)	181-200 (358-392)	166-180 (331-356)	161-165 (322-329)	136-160 (277-320)	121-135 (250-275)	101-120 (214-248)	86-100 (187-212)	85 (185)

“T” #	ATEX/IECEX					
	T1	T2	T3	T4	T5	T6
Temp. Range °C (°F)	301-450 (547-842)	201-300 (394-572)	136-200 (277-392)	101-135 (214-275)	86-100 (187-212)	85 (185)

① T numbers represent the maximum internal temperature for Class I, Division 2 and Class I, Zone 2 locations designated by the NEC.

② T numbers represent the maximum surface temperature under a dust blanket for Class II, Division 1 and Class I, Zone 2 as designated by the NEC or Zone 2 (Gas) and 22 (Dust) locations as designated by the IEC.

③ Lamp type is not certified for use in ATEX/IECEX.

Mercmaster™ LED Series Luminaires

Enclosed and Gasketed Fixtures

NEC/CEC:
 Class I, Division 2, Groups A, B, C, D
 Class I, Zone 2, AEx nA IIC
 Class II, Division 1, Group E, F, G
 Class II, Division 2, Group F, G
 Class III

NEC/CEC:
 Type 3R, 4, 4X
 IP66/67
 Simultaneous Exposure
 Suitable for Use in Wet Locations
 Marine Outside Type (Salt Water)

ATEX/IECEX:
 Zone 2 and 22
 II 2 GD
 IP66/67

Lamp Comparison Chart

Lamp Data	Line Current Amps	Input Power	Lumens	CRI	Lamp Life (Hours)	Color Temp CCT
NEMA Type V						
MLEDN70	.31 @ 120 V	35	2300	70	60,000+	5650
	.17 @ 277 V	33				
	.24 @ 347 V	34				
	.11 @ 480 V	32				
MLEDN100	.41 @ 120 V	47.5	3450	70	60,000+	5650
	.20 @ 277 V	46				
	.25 @ 347 V	42				
	.12 @ 480 V	44				
MLEDN150	.53 @ 120 V	61	4850	70	60,000+	5650
	.25 @ 277 V	62				
	.29 @ 347 V	62				
	.14 @ 480 V	64				
MLEDN175	.63 @ 120 V	74	6076	70	60,000+	5650
	.28 @ 277 V	72				
	.25 @ 347 V	86				
	.16 @ 480 V	88				
MLEDN250 ①	.83 @ 120 V	95.5	9455	70	60,000+	5650
	.36 @ 277 V	92				
	.45 @ 347 V	96				
	.31 @ 480 V	95				
MLEDN350 ①	.30 @ 347 V	102	11425	70	60,000+	5650
	.23 @ 480 V	103				
MLEDN400	1.04 @ 120 V	127	12850	70	60,000+	5650
	.47 @ 277 V	128				
NEMA Type I						
MLEDN100 ①	.41 @ 120 V	47.5	2900	70	60,000+	5650
	.20 @ 277 V	46				
	.25 @ 347 V	47.5				
	.12 @ 480 V	46				
MLEDN175 ①	.61 @ 120 V	70	6200	70	60,000+	5650
	.28 @ 277 V	69				
	.24 @ 347 V	70				
	.16 @ 480 V	69				



① Lamp type is not certified for use in ATEX/IEC.

Mercmaster™ LED Series Luminaires

Enclosed and Gasketed Fixtures

NEC/CEC:
Class I, Division 2, Groups A, B, C, D
Class I, Zone 2, AEx nA IIC
Class II, Division 1, Group E, F, G
Class II, Division 2, Group F, G
Class III

NEC/CEC:
Type 3R, 4, 4X
IP66/67
Simultaneous Exposure
Suitable for Use in Wet Locations
Marine Outside Type (Salt Water)

	LED Wattage BU/BH	Lamp Wattage Equivalent	NEMA Type	Hub Size	Conformance	NEC/CEC Catalog Numbers ②③④⑤
Pendant — One Hub, Rigid Mounting						
	35/33 W	70 W HPS/PSMH	Type V	3/4	NEC/CEC	MLEDNA702P5
	47.5/46 W	100 W HPS/PSMH	Type V	3/4	NEC/CEC	MLEDNA102P5
	46.7/46.6 W	100 W HPS/PSMH	Type I	3/4	NEC/CEC	MLEDNA102P1 ①
	61/62 W	150 W HPS/PSMH	Type V	3/4	NEC/CEC	MLEDNA152P5
	74/72 W	175 W PSMH	Type V	3/4	NEC/CEC	MLEDNA172P5
	70/69 W	175 W PSMH	Type I	3/4	NEC/CEC	MLEDNA172P1 ①
	95.5/92 W	250 W HPS/MH	Type V	3/4	NEC/CEC	MLEDNA252P5
	102/103 W	350 W PSMH	Type V	3/4	NEC/CEC	MLEDNA352P5 ⑥
	127/128 W	400 W HPS/PSMH	Type V	3/4	NEC/CEC	MLEDNA402P5 ⑦
	35/33 W	70 W HPS/PSMH	Type V	1	NEC/CEC	MLEDNA703P5
	47.5/46 W	100 W HPS/PSMH	Type V	1	NEC/CEC	MLEDNA103P5
	46.7/46.6 W	100 W HPS/PSMH	Type I	1	NEC/CEC	MLEDNA103P1 ①
	61/62 W	150 W HPS/PSMH	Type V	1	NEC/CEC	MLEDNA153P5
	74/72 W	175 W PSMH	Type V	1	NEC/CEC	MLEDNA173P5
	70/64 W	175 W PSMH	Type I	1	NEC/CEC	MLEDNA173P1 ①
	95.5/92 W	250 W HPS/PSMH	Type V	1	NEC/CEC	MLEDNA253P5
102/103 W	350 W PSMH	Type V	1	NEC/CEC	MLEDNA353P5 ⑥	
127/128 W	400 W HPS/PSMH	Type V	1	NEC/CEC	MLEDNA403P5 ⑦	
Pendant Cone — One Hub, Rigid Mounting						
	35/33 W	70 W HPS/PSMH	Type V	3/4	NEC/CEC	MLEDND702P5
	47.5/46 W	100 W HPS/PSMH	Type V	3/4	NEC/CEC	MLEDND102P5
	46.7/46.6 W	100 W HPS/PSMH	Type I	3/4	NEC/CEC	MLEDND102P1 ①
	61/62 W	150 W HPS/PSMH	Type V	3/4	NEC/CEC	MLEDND152P5
	74/72 W	175 W PSMH	Type V	3/4	NEC/CEC	MLEDND172P5
	70/64 W	175 W PSMH	Type I	3/4	NEC/CEC	MLEDND172P1 ①
	95.5/92 W	250 W HPS/PSMH	Type V	3/4	NEC/CEC	MLEDND252P5
	102/103 W	350 W PSMH	Type V	3/4	NEC/CEC	MLEDND352P5 ⑥
	127/128 W	400 W HPS/PSMH	Type V	3/4	NEC/CEC	MLEDND402P5 ⑦
	35/33 W	70 W HPS/PSMH	Type V	1	NEC/CEC	MLEDND703P5
	47.5/46 W	100 W HPS/PSMH	Type V	1	NEC/CEC	MLEDND103P5
	46.7/46.6 W	100 W HPS/PSMH	Type I	1	NEC/CEC	MLEDND103P1 ①
	61/62 W	150 W HPS/PSMH	Type V	1	NEC/CEC	MLEDND153P5
	74/72 W	175 W PSMH	Type V	1	NEC/CEC	MLEDND173P5
	70/64 W	175 W PSMH	Type I	1	NEC/CEC	MLEDND173P1 ①
	95.5/92 W	250 W HPS/PSMH	Type V	1	NEC/CEC	MLEDND253P5
102/103 W	350 W PSMH	Type V	1	NEC/CEC	MLEDND353P5 ⑥	
127/128 W	400 W HPS/PSMH	Type V	1	NEC/CEC	MLEDND403P5 ⑦	

① NEMA Type I Elliptical.

② Voltage specifications: for 120-277 Vac, 50/60 Hz universal voltages add **-BU** to the end of the catalog number. For 347-480 Vac, 50/60 Hz add **-BH** to the end of the catalog number. Example: MLEDNA702P5BU.

③ For optional diffused globe, add suffix **-D** to the end of the catalog number.

④ For optional fusing, add suffix **-F** to the end of the catalog number.

⑤ For optional photocontrols add the appropriate suffix to the end of the catalog number: **-H1** for 120 V; **-H2** for 208 V; **-H3** for 240 V; **-H4** for 277 V. Luminaires with photocontrol are not rated IP66/67, Type 4X or marine outside type (salt water). Ceiling mount luminaires are not designed to use the PCD2 photocontrol. Ceiling mounts must use an FS/FD box with a photocontrol. Contact your local sales representative for more information.

⑥ Available for use with the BH voltage only (347-480 Vac, 50/60 Hz).

⑦ Available for use with the BU voltage only (120-277 Vac, 50/60 Hz).

Mercmaster™ LED Series Luminaires



Enclosed and Gasketed Fixtures

NEC/CEC:

Class I, Division 2, Groups A, B, C, D
 Class I, Zone 2, AEx nA IIC
 Class II, Division 1, Group E, F, G
 Class II, Division 2, Group F, G
 Class III

NEC/CEC:

Type 3R, 4, 4X
 IP66/67
 Simultaneous Exposure
 Suitable for Use in Wet Locations
 Marine Outside Type (Salt Water)

	LED Wattage BU/BH	Lamp Wattage Equivalent	NEMA Type	Hub Size	Conformance	NEC/CEC Catalog Numbers ②③④⑤
Ceiling — Five Hubs, Four Close-up Plugs						
	35/33 W	70 W HPS/PSMH	Type V	3/4	NEC/CEC	MLEDNC702P5
	47.5/46 W	100 W HPS/PSMH	Type V	3/4	NEC/CEC	MLEDNC102P5
	46.7/46.6 W	100 W HPS/PSMH	Type I	3/4	NEC/CEC	MLEDNC102P1 ①
	61/62 W	150 W HPS/PSMH	Type V	3/4	NEC/CEC	MLEDNC152P5
	74/72 W	175 W PSMH	Type V	3/4	NEC/CEC	MLEDNC172P5
	70/64 W	175 W PSMH	Type I	3/4	NEC/CEC	MLEDNC172P1 ①
	95.5/92 W	250 W HPS/PSMH	Type V	3/4	NEC/CEC	MLEDNC252P5
	102/103 W	350 W PSMH	Type V	3/4	NEC/CEC	MLEDNC352P5 ⑥
	127/128 W	400 W HPS/PSMH	Type V	3/4	NEC/CEC	MLEDNC402P5 ⑦
	35/33 W	70 W HPS/PSMH	Type V	1	NEC/CEC	MLEDNC703P5
	47.5/46 W	100 W HPS/PSMH	Type V	1	NEC/CEC	MLEDNC103P5
	46.7/46.6 W	100 W HPS/PSMH	Type I	1	NEC/CEC	MLEDNC103P1 ①
	61/62 W	150 W HPS/PSMH	Type V	1	NEC/CEC	MLEDNC153P5
	74/72 W	175 W PSMH	Type V	1	NEC/CEC	MLEDNC173P5
70/64 W	175 W PSMH	Type I	1	NEC/CEC	MLEDNC173P1 ①	
95.5/92 W	250 W HPS/PSMH	Type V	1	NEC/CEC	MLEDNC253P5	
102/103 W	350 W PSMH	Type V	1	NEC/CEC	MLEDNC353P5 ⑥	
127/128 W	400 W HPS/PSMH	Type V	1	NEC/CEC	MLEDNC403P5 ⑦	
Wall — Five Hubs, Four Close-up Plugs						
	35/33 W	70 W HPS/PSMH	Type V	3/4	NEC/CEC	MLEDNW702P5
	47.5/46 W	100 W HPS/PSMH	Type V	3/4	NEC/CEC	MLEDNW102P5
	46.7/46.6 W	100 W HPS/PSMH	Type I	3/4	NEC/CEC	MLEDNW102P1 ①
	61/62 W	150 W HPS/PSMH	Type V	3/4	NEC/CEC	MLEDNW152P5
	74/72 W	175 W PSMH	Type V	3/4	NEC/CEC	MLEDNW172P5
	70/64 W	175 W PSMH	Type I	3/4	NEC/CEC	MLEDNW172P1 ①
	95.5/92 W	250 W HPS/PSMH	Type V	3/4	NEC/CEC	MLEDNW252P5
	102/103 W	350 W PSMH	Type V	3/4	NEC/CEC	MLEDNW352P5 ⑥
	127/128 W	400 W HPS/PSMH	Type V	3/4	NEC/CEC	MLEDNW402P5 ⑦
	35/33 W	70 W HPS/PSMH	Type V	1	NEC/CEC	MLEDNW703P5
	47.5/46 W	100 W HPS/PSMH	Type V	1	NEC/CEC	MLEDNW103P5
	46.7/46.6 W	100 W HPS/PSMH	Type I	1	NEC/CEC	MLEDNW103P1 ①
	61/62 W	150 W HPS/PSMH	Type V	1	NEC/CEC	MLEDNW153P5
	74/72 W	175 W PSMH	Type V	1	NEC/CEC	MLEDNW173P5
70/64 W	175 W PSMH	Type I	1	NEC/CEC	MLEDNW173P1 ①	
95.5/92 W	250 W HPS/PSMH	Type V	1	NEC/CEC	MLEDNW253P5	
102/103 W	350 W PSMH	Type V	1	NEC/CEC	MLEDNW353P5 ⑥	
127/128 W	400 W HPS/PSMH	Type V	1	NEC/CEC	MLEDNW403P5 ⑦	

① NEMA Type I Elliptical.

② Voltage specifications: for 120-277 Vac, 50/60 Hz universal voltages add **-BU** to the end of the catalog number. For 347-480 Vac, 50/60 Hz add **-BH** to the end of the catalog number. Example: MLEDNA702P5BU.

③ For optional diffused globe, add suffix **-D** to the end of the catalog number.

④ For optional fusing, add suffix **-F** to the end of the catalog number.

⑤ For optional photocontrols add the appropriate suffix to the end of the catalog number: **-H1** for 120 V; **-H2** for 208 V; **-H3** for 240 V; **-H4** for 277 V. Luminaires with photocontrol are not rated IP66/67, Type 4X or marine outside type (salt water). Ceiling mount luminaires are not designed to use the PCD2 photocontrol. Ceiling mounts must use an FS/FD box with a photocontrol. Contact your local sales representative for more information.

⑥ Available for use with the BH voltage only (347-480 Vac, 50/60 Hz).

⑦ Available for use with the BU voltage only (120-277 Vac, 50/60 Hz).

Mercmaster™ LED Series Luminaires



Enclosed and Gasketed Fixtures

NEC/CEC:

Class I, Division 2, Groups A, B, C, D
 Class I, Zone 2, AEx nA IIC
 Class II, Division 1, Group E, F, G
 Class II, Division 2, Group F, G
 Class III

NEC/CEC:

Type 3R, 4, 4X
 IP66/67
 Simultaneous Exposure
 Suitable for Use in Wet Locations
 Marine Outside Type (Salt Water)

	LED Wattage BU/BH	Lamp Wattage Equivalent	NEMA Type	Hub Size	Conformance	NEC/CEC Catalog Numbers ②③④⑤
25° Stanchion — One Hub						
	35/33 W	70 W HPS/PSMH	Type V	1-1/4	NEC/CEC	MLEDNS704P5
	47.5/46 W	100 W HPS/PSMH	Type V	1-1/4	NEC/CEC	MLEDNS104P5
	46.7/46.6 W	100 W HPS/PSMH	Type I	1-1/4	NEC/CEC	MLEDNS104P1 ①
	61/62 W	150 W HPS/PSMH	Type V	1-1/4	NEC/CEC	MLEDNS154P5
	74/72 W	175 W PSMH	Type V	1-1/4	NEC/CEC	MLEDNS174P5
	70/64 W	175 W PSMH	Type I	1-1/4	NEC/CEC	MLEDNS174P1 ①
	95.5/92 W	250 W HPS/PSMH	Type V	1-1/4	NEC/CEC	MLEDNS254P5
	102/103 W	350 W PSMH	Type V	1-1/4	NEC/CEC	MLEDNS354P5 ⑥
	127/128 W	400 W HPS/PSMH	Type V	1-1/4	NEC/CEC	MLEDNS404P5 ⑦
	35/33 W	70 W HPS/PSMH	Type V	1-1/2	NEC/CEC	MLEDNS705P5
	47.5/46 W	100 W HPS/PSMH	Type V	1-1/2	NEC/CEC	MLEDNS105P5
	46.7/46.6 W	100 W HPS/PSMH	Type I	1-1/2	NEC/CEC	MLEDNS105P1 ①
	61/62 W	150 W HPS/PSMH	Type V	1-1/2	NEC/CEC	MLEDNS155P5
	74/72 W	175 W PSMH	Type V	1-1/2	NEC/CEC	MLEDNS175P5
70/64 W	175 W PSMH	Type I	1-1/2	NEC/CEC	MLEDNS175P1 ①	
95.5/92 W	250 W HPS/PSMH	Type V	1-1/2	NEC/CEC	MLEDNS255P5	
102/103 W	350 W PSMH	Type V	1-1/2	NEC/CEC	MLEDNS355P5 ⑥	
127/128 W	400 W HPS/PSMH	Type V	1-1/2	NEC/CEC	MLEDNS405P5 ⑦	
90° Stanchion — One Hub						
	35/33 W	70 W HPS/PSMH	Type V	1-1/4	NEC/CEC	MLEDNR704P5
	47.5/46 W	100 W HPS/PSMH	Type V	1-1/4	NEC/CEC	MLEDNR104P5
	46.7/46.6 W	100 W HPS/PSMH	Type I	1-1/4	NEC/CEC	MLEDNR104P1 ①
	61/62 W	150 W HPS/PSMH	Type V	1-1/4	NEC/CEC	MLEDNR154P5
	74/72 W	175 W PSMH	Type V	1-1/4	NEC/CEC	MLEDNR174P5
	70/64 W	175 W PSMH	Type I	1-1/4	NEC/CEC	MLEDNR174P1 ①
	95.5/92 W	250 W HPS/PSMH	Type V	1-1/4	NEC/CEC	MLEDNR254P5
	102/103 W	350 W PSMH	Type V	1-1/4	NEC/CEC	MLEDNR354P5 ⑥
	127/128 W	400 W HPS/PSMH	Type V	1-1/4	NEC/CEC	MLEDNR404P5 ⑦
	35/33 W	70 W HPS/PSMH	Type V	1-1/2	NEC/CEC	MLEDNR705P5
	47.5/46 W	100 W HPS/PSMH	Type V	1-1/2	NEC/CEC	MLEDNR105P5
	46.7/46.6 W	100 W HPS/PSMH	Type I	1-1/2	NEC/CEC	MLEDNR105P1 ①
	61/62 W	150 W HPS/PSMH	Type V	1-1/2	NEC/CEC	MLEDNR155P5
	74/72 W	175 W PSMH	Type V	1-1/2	NEC/CEC	MLEDNR175P5
70/64 W	175 W PSMH	Type I	1-1/2	NEC/CEC	MLEDNR175P1 ①	
95.5/92 W	250 W HPS/PSMH	Type V	1-1/2	NEC/CEC	MLEDNR255P5	
102/103 W	350 W PSMH	Type V	1-1/2	NEC/CEC	MLEDNR355P5 ⑥	
127/128 W	400 W HPS/PSMH	Type V	1-1/2	NEC/CEC	MLEDNR405P5 ⑦	

① NEMA Type I Elliptical.

② Voltage specifications: for 120-277 Vac, 50/60 Hz universal voltages add **-BU** to the end of the catalog number. For 347-480 Vac, 50/60 Hz add **-BH** to the end of the catalog number. Example: MLEDNA702P5BU.

③ For optional diffused globe, add suffix **-D** to the end of the catalog number.

④ For optional fusing, add suffix **-F** to the end of the catalog number.

⑤ For optional photocontrols add the appropriate suffix to the end of the catalog number: **-H1** for 120 V; **-H2** for 208 V; **-H3** for 240 V; **-H4** for 277 V. Luminaires with photocontrol are not rated IP66/67, Type 4X or marine outside type (salt water). Ceiling mount luminaires are not designed to use the PCD2 photocontrol. Ceiling mounts must use an FS/FD box with a photocontrol. Contact your local sales representative for more information.

⑥ Available for use with the BH voltage only (347-480 Vac, 50/60 Hz).

⑦ Available for use with the BU voltage only (120-277 Vac, 50/60 Hz).

Mercmaster™ LED Series Luminaires

Enclosed and Gasketed Fixtures

NEC/CEC:
 Class I, Division 2, Groups A, B, C, D
 Class I, Zone 2, AEx nA IIC
 Class II, Division 1, Group E, F, G
 Class II, Division 2, Group F, G
 Class III

NEC/CEC:
 Type 3R, 4, 4X
 IP66/67
 Simultaneous Exposure
 Suitable for Use in Wet Locations
 Marine Outside Type (Salt Water)

Fixture Unit — Electrical Specification



LED Wattage BU/BH	Light Level Equivalent	NEMA Type	Current Draw	Catalog Number			Voltage Range	Voltage Suffix
				Fuse Kit	Fixture Unit	Conformance		
NEC/CEC Certified Ballast Housing								
35/33 W	70 W HPS	Type V	120 Vac @ .31 Amps 277 Vac @ .17 Amps	F3	MLEDN70P5	NEC/CEC	120-277 Vac, 50/60 Hz	BU
34/32 W	70 W HPS	Type V	347 Vac @ .24 Amps 480 Vac @ .11 Amps	F3	MLEDN70P5	NEC/CEC	347-480 Vac, 50/60 Hz	BH
47.5/46 W	100 W HPS	Type V	120 Vac @ .41 Amps 277 Vac @ .20 Amps	F3	MLEDN10P5	NEC/CEC	120-277 Vac, 50/60 Hz	BU
47.5/46 W	100 W HPS	Type I	120 Vac @ .41 Amps 277 Vac @ .20 Amps	F3	MLEDN10P1	NEC/CEC	120-277 Vac, 50/60 Hz	BU
42/44 W	100 W HPS	Type V	347 Vac @ .25 Amps 480 Vac @ .12 Amps	F3	MLEDN10P5	NEC/CEC	347-480 Vac, 50/60 Hz	BH
47.5/46 W	100 W HPS	Type I	347 Vac @ .25 Amps 480 Vac @ .12 Amps	F3	MLEDN10P1	NEC/CEC	347-480 Vac, 50/60 Hz	BH
61/62 W	150 W HPS	Type V	120 Vac @ .53 Amps 277 Vac @ .25 Amps	F3	MLEDN15P5	NEC/CEC	120-277 Vac, 50/60 Hz	BU
62/64 W	150 W HPS	Type V	347 Vac @ .29 Amps 480 Vac @ .14 Amps	F3	MLEDN15P5	NEC/CEC	347-480 Vac, 50/60 Hz	BH
74/72 W	175 W PSMH	Type V	120 Vac @ .63 Amps 277 Vac @ .28 Amps	F3	MLEDN17P5	NEC/CEC	120-277 Vac, 50/60 Hz	BU
70/69 W	175 W PSMH	Type I	120 Vac @ .61 Amps 277 Vac @ .28 Amps	F3	MLEDN17P1	NEC/CEC	120-277 Vac, 50/60 Hz	BU
86/88 W	175 W PSMH	Type V	347 Vac @ .25 Amps 480 Vac @ .16 Amps	F3	MLEDN17P5	NEC/CEC	347-480 Vac, 50/60 Hz	BH
70/69 W	175 W PSMH	Type I	347 Vac @ .24 Amps 480 Vac @ .16 Amps	F3	MLEDN17P1	NEC/CEC	347-480 Vac, 50/60 Hz	BH
95.5/92 W	250 W HPS/PSMH	Type V	120 Vac @ .83 Amps 277 Vac @ .36 Amps	F3	MLEDN25P5	NEC/CEC	120-277 Vac, 50/60 Hz	BU
96/95 W	250 W HPS/PSMH	Type V	347 Vac @ .45 Amps 480 Vac @ .31 Amps	F3	MLEDN25P5	NEC/CEC	347-480 Vac, 50/60 Hz	BH
102/103 W	350 W PSMH	Type V	347 Vac @ .30 Amps 480 Vac @ .23 Amps	F3	MLEDN35P5	NEC/CEC	347-480 Vac, 50/60 Hz	BH
127/128 W	400 W HPS/PSMH	Type V	120 Vac @ 1.04 Amps 277 Vac @ .47 Amps	F3	MLEDN40P5	NEC/CEC	120-277 Vac, 50/60 Hz	BU

Mercmaster™ LED Series Luminaires

Enclosed and Gasketed Fixtures

ATEX/IECEX:
Zone 2 and 22
II 2 GD
IP66/67

Fixture Unit — Electrical Specification



LED Wattage BU/BH	Light Level Equivalent	NEMA Type	Current Draw	Conformance	Voltage Range	Voltage Suffix	Fixture Unit Catalog Number
ATEX/IECEX Certified Ballast Housing ①							
35/33 W	70 W HPS	Type V	120 Vac @ .31 Amps 277 Vac @ .17 Amps	ATEX/IECEX	120-277 Vac, 50/60 Hz	BU	MLEDNA70P5
47.5/46 W	100 W HPS	Type V	120 Vac @ .41 Amps 277 Vac @ .20 Amps	ATEX/IECEX	120-277 Vac, 50/60 Hz	BU	MLEDNA10P5
61/62 W	150 W HPS	Type V	120 Vac @ .53 Amps 277 Vac @ .25 Amps	ATEX/IECEX	120-277 Vac, 50/60 Hz	BU	MLEDNA15P5
74/72 W	175 W PSMH	Type V	120 Vac @ .63 Amps 277 Vac @ .28 Amps	ATEX/IECEX	120-277 Vac, 50/60 Hz	BU	MLEDNA17P5
95.5/92 W	250 W HPS/PSMH	Type V	120 Vac @ .83 Amps 277 Vac @ .36 Amps	ATEX/IECEX	120-277 Vac, 50/60 Hz	BU	MLEDNA25P5

① For ATEX/IECEX rated fixtures, ballast bodies and mounting hoods must be purchased separately.

Mercmaster™ LED Series Luminaires

Enclosed and Gasketed Fixtures

NEC/CEC:

Class I, Division 2, Groups A, B, C, D
 Class I, Zone 2, AEx nA IIC
 Class II, Division 1, Group E, F, G
 Class II, Division 2, Group F, G
 Class III







NEC/CEC:

Type 3R, 4, 4X
 IP66/67
 Simultaneous Exposure
 Suitable for Use in Wet Locations
 Marine Outside Type (Salt Water)

ATEX/IECEX:

Zone 2 and 22
 II 2 GD
 IP66/67

Mounting Hoods ①

	Description	Hub Size	Catalog Number NEC/CEC and ATEX/IEC
Pendant			
	One Hub, Rigid Mounting	3/4	KPA-75
		1	KPA-100
		M20	KPA-M20
Pendant Cone			
	One Hub, Rigid Mounting	3/4	KPCH-75
		1	KPCH-100
		M20	KPCH-M20
Ceiling			
	Five Hubs, Four Close-Up Plugs	3/4	KPC-75
		1	KPC-100
		M20	KPC-M20
Wall			
	Five Hubs, Four Close-Up Plugs	3/4	KPWB-75
		1	KPWB-100
		M20	KPWB-M20
25° Stanchion			
	One Hub	1-1/4	KPS-125
		1-1/2	KPS-150
90° Stanchion			
	One Hub	1-1/4	KPST-125
		1-1/2	KPST-150

Mercmaster LED Ballast and Mounting Hood Weights

Description	Weight kg (lb)
Fixture Unit (Ballast Housing)	8.8 (19.4)
Pendant Mounting Hood	1.0 (2.25)
Pendant Cone Mounting Hood	1.1 (2.50)
Ceiling Mounting Hood	1.4 (3.00)
Wall Mounting Hood	1.8 (4.00)
25° Stanchion Mounting Hood	1.5 (3.25)
90° Stanchion Mounting Hood	1.7 (3.75)

① For ATEX/IECEX rated fixtures, ballast bodies and mounting hoods must be purchased separately.

Mercmaster™ LED Series Luminaires

Enclosed and Gasketed Fixtures

NEC/CEC:

Class I, Division 2, Groups A, B, C, D
 Class I, Zone 2, AEx nA IIC
 Class II, Division 1, Group E, F, G
 Class II, Division 2, Group F, G
 Class III





NEC/CEC:

Type 3R, 4, 4X
 IP66/67
 Simultaneous Exposure
 Suitable for Use in Wet Locations
 Marine Outside Type (Salt Water)

ATEX/IECEX:

Zone 2 and 22
 II 2 GD
 IP66/67

Accessories and Replacement Parts

	Description	Catalog Number	
		NEC/CEC	ATEX/IECEX
Globes and Gaskets			
	Clear Globe	VPGL-LED	
	Diffused Globe	VPGL-DIFF	
	Globe Gasket — Silicone Rubber	KRF-GK	
Closed Prismatic Glass Refractors — All Heat-Resistant			
	NEMA Type V Light Distribution	LPG-R5	
Glass Refractor			

	Description	Catalog Number	
		NEC/CEC	ATEX/IECEX
LED Array			
	100 Watt LED Array Assembly, Type I, White LED's	MLEDN10A1W	MLEDN10A1W
	175 Watt LED Array Assembly, Type I, White LED's	MLEDN17A1W	MLEDN17A1W
	70 Watt LED Array Assembly, Type V, White LED's	MLEDN70A5W	MLEDN70A5W
	100 Watt LED Array Assembly, Type V, White LED's	MLEDN10A5W	MLEDN10A5W
	150 Watt LED Array Assembly, Type V, White LED's	MLEDN15A5W	MLEDN15A5W
	175 Watt LED Array Assembly, Type V, White LED's	MLEDN17A5W	MLEDN17A5W
	250 Watt LED Array Assembly, Type V, White LED's	MLEDN25A5W	MLEDN25A5W
	350 Watt LED Array Assembly, Type V, White LED's	MLEDN35A5W	—
	400 Watt LED Array Assembly, Type V, White LED's	MLEDN40A5W	—
Drivers			
	120-277 V Driver (70 W thru 250 W only)	MLEDNDBU	MLEDNDBU
	347-480 V Driver (70 W thru 350 W only)	MLEDNDBH	MLEDNDBH
	120-277 V Driver (400 W only)	MLEDNDBU40	—

Mercmaster™ LED Series Luminaires

Enclosed and Gasketed Fixtures

NEC/CEC:

Class I, Division 2, Groups A, B, C, D
 Class I, Zone 2, AEx nA IIC
 Class II, Division 1, Group E, F, G
 Class II, Division 2, Group F, G
 Class III

NEC/CEC:

Type 3R, 4, 4X
 IP66/67
 Simultaneous Exposure
 Suitable for Use in Wet Locations
 Marine Outside Type (Salt Water)

ATEX/IECEX:

Zone 2 and 22
 II 2 GD
 IP66/67

Dimensions in Millimeters (Inches)

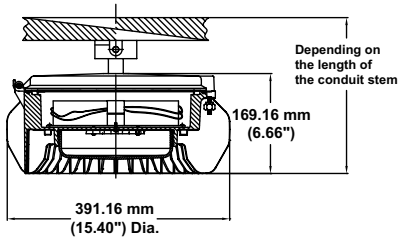

Pendant Mount

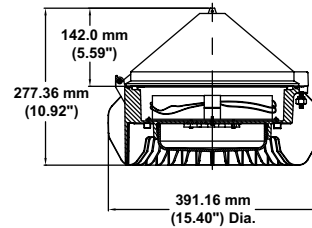

Pendant Cone Mount

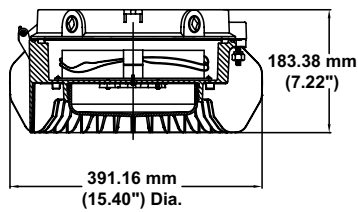

Ceiling Mount

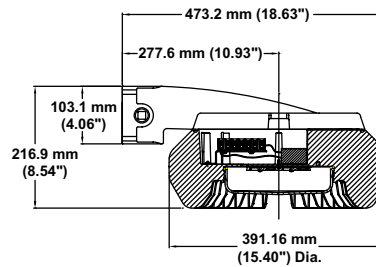

Wall Mount

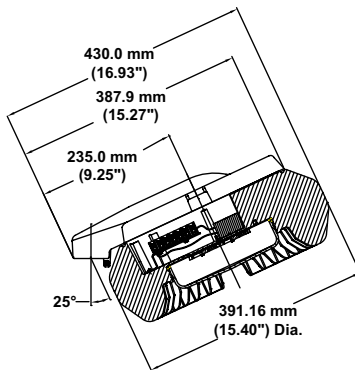

25° Stanchion Mount

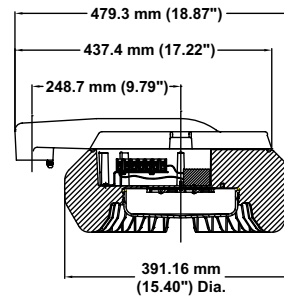

90° Stanchion Mount

PCD2 Series Factory Sealed Hazardous Location Photocontrol^①

For Use in Class I, Division 2, Groups A, B, C, D Locations

Maintains Class I, Division 2 rating for Mercmaster III, Mercmaster III Low Profile, Mercmaster III 50-250 and 400 Series Luminaires; Mercmaster LED Series.

NEC/CEC:
Class I, Division 2, Groups A, B, C, D
NEMA 4X

Applications

- Encapsulated photocontrol provides automatic dusk-to-dawn lighting control in Class I, Division 2 locations.
- Typical applications include walkways, security areas and any other outdoor lighting application.
- For use with Mercmaster III – Low Profile, Mercmaster III, and Mercmaster III – 400 Series Luminaires.
- For remote mounting in FS Boxes.

Features

- Factory sealed design eliminates the need for an explosionproof enclosure.
- Can be easily installed in the field.
- Solid state design for performance and reliability.
- Available for 120, 208, 240, or 277 volts.

- 50-400 W HID, incandescent or fluorescent, 50/60 Hz.
- 1000 V.A. Voltage/Ampere
- Minimum time delay: 15 seconds to eliminate nuisance tripping.
- Provided with (3) 18AWG stranded leads 152.4 mm (6.00 in) length.
- Will fit through standard 1/2" knockout.
- Supplied with locknut and gasket.

Materials

- Encapsulated with epoxy sealing compound
- FS: aluminum

NEC/CEC Certifications and Compliances

- UL Standard: 1604 – Hazardous (Classified) Locations
- cULus Recognized

	Voltage Range	Max VA	Max Current Amps	Suffix Designation Catalog Number
Factory-Installed Photocontrol - Not for ceiling or pendant cone Add to fixture catalog after voltage; i.e.: KPWB1075MTH1.				
	120 V, 50/60 Hz	1000	—	H1
	208 V, 50/60 Hz	1000	—	H2
	240 V, 50/60 Hz	1000	—	H3
	277 V, 50/60 Hz	1000	—	H4

Photocontrol for Field Installation

	120 V, 50/60 Hz	1000	8.3 Amp	PC120D2
	208 V, 50/60 Hz	1000	4.8 Amp	PC247D2
	240 V, 50/60 Hz	1000	4.2 Amp	
	277 V, 50/60 Hz	1000	3.6 Amp	

Photocontrol in FS Cover for Use with FS/FD Box

Photocontrol assembly supplied with two stainless steel screws and one neoprene gasket.
For additional neoprene gaskets, order catalog numbers **FS-GKR-1N**.

	120V, 50/60 Hz	1000	8.3 Amp	FSKA-PC120D2
	208 V, 50/60 Hz	1000	4.8 Amp	FSKA-PC247D2
	240 V, 50/60 Hz	1000	4.2 Amp	
	277 V, 50/60 Hz	1000	3.6 Amp	

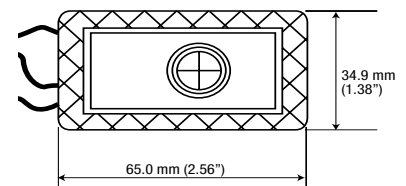
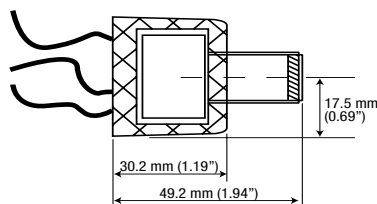
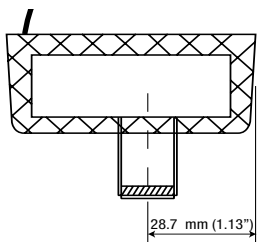

^① Fixtures with photocontrols are not rated IP66/67, Type 4X or marine outside type (salt water).
Fixtures with PCD2 photocontrols are not certified for use in ATEX/IEC governed locations.

Mercmaster™ LED Series Luminaires

Enclosed and Gasketed Fixtures

NEC/CEC:
 Class I, Division 2, Groups A, B, C, D
 Class I, Zone 2, AEx nA IIC
 Class II, Division 1, Group E, F, G
 Class II, Division 2, Group F, G
 Class III

NEC/CEC:
 Type 3R, 4, 4X
 IP66/67
 Simultaneous Exposure
 Suitable for Use in Wet Locations
 Marine Outside Type (Salt Water)

ATEX/IECEX:
 Zone 2 and 22
 II 2 GD
 IP66/67

Photometric Data – DATA SHOWN IS ABSOLUTE

REPORT NUMBER: **MLEDN70P5BU**

Lamps: Mercmaster LED, Class I, Division 2, Polycarbonate Optic

Candela Distribution

	0.0	22.5	45.0	67.5	90.0	Flux
0	1054	1054	1054	1054	1054	
5	1048	1047	1051	1047	1048	100
15	1016	1014	1016	1014	1016	287
25	977	961	941	961	977	442
35	805	779	824	779	805	497
45	583	607	603	607	583	465
55	408	425	411	425	408	358
65	185	146	139	146	185	133
75	5	5	4	5	5	9
85	1	0	0	0	1	1
90	0	0	0	0	0	

Zonal Lumen Summary

Zone	Lumens	% Fixture
0-30	829	36.1
0-40	1326	57.7
0-60	2149	93.5
0-90	2292	99.7

CIE Type – Direct

Plane	Spacing Criteria
0-Deg	90-Deg
1.3	1.3

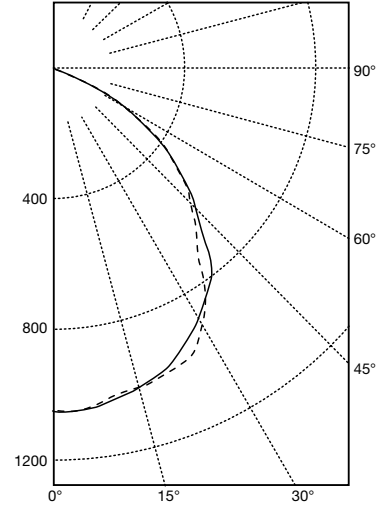

REPORT NUMBER: **MLEDN10P5BU**

Lamps: Mercmaster LED, Class I, Division 2, Polycarbonate Optic

Candela Distribution

	0.0	22.5	45.0	67.5	90.0	Flux
0	1580	1580	1580	1580	1580	
5	1569	1568	1568	1568	1569	149
15	1509	1510	1513	1510	1509	427
25	1412	1414	1437	1414	1412	655
35	1177	1215	1171	1215	1177	748
45	934	915	893	915	934	707
55	577	588	632	588	577	527
65	228	218	195	218	228	209
75	6	7	6	7	6	13
85	0	0	0	0	0	1
90	0	0	0	0	0	

Zonal Lumen Summary

Zone	Lumens	% Fixture
0-30	1231	35.8
0-40	1980	57.6
0-60	3213	93.5
0-90	3438	100.0

CIE Type – Direct

Plane	Spacing Criteria
0-Deg	90-Deg
1.2	1.2

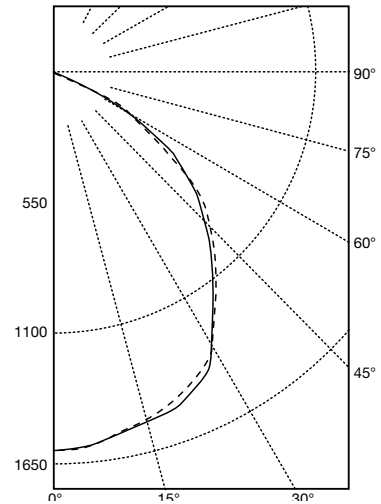

Mercmaster™ LED Series Luminaires

Enclosed and Gasketed Fixtures

NEC/CEC:

Class I, Division 2, Groups A, B, C, D
 Class I, Zone 2, AEx nA IIC
 Class II, Division 1, Group E, F, G
 Class II, Division 2, Group F, G
 Class III

NEC/CEC:

Type 3R, 4, 4X
 IP66/67
 Simultaneous Exposure
 Suitable for Use in Wet Locations
 Marine Outside Type (Salt Water)

ATEX/IECEX:

Zone 2 and 22
 II 2 GD
 IP66/67

Photometric Data – DATA SHOWN IS ABSOLUTE

REPORT NUMBER: **MLEDN10P1BU (NEMA Type I)**

Lamps: Mercmaster LED, Class I, Division 2, Polycarbonate Optic

Candela Distribution	
Zone	Lumen
0-10	276.95
10-20	715.67
20-30	650.02
30-40	492.78
40-50	369.94
50-60	232.10
60-70	127.75
70-80	22.49
80-90	2.23

CIE Type – Direct	
Plane	Spacing Criteria
0-Deg	90-Deg
0.74	0.74

Zonal Lumen Summary		
Zone	Lumens	% Fixture
0-20	992.62	34.3
0-30	1642.65	56.8
0-40	2135.42	73.8
0-60	2737.46	94.7
0-80	2887.70	99.8
0-90	2889.93	99.9

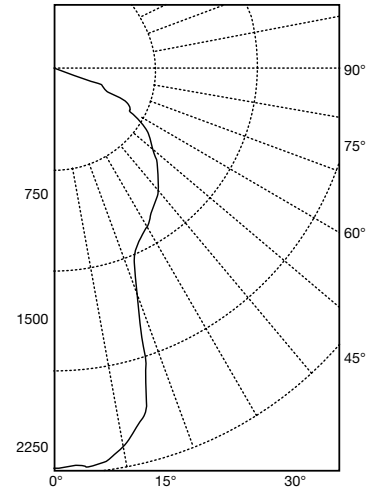

REPORT NUMBER: **MLEDN15P5BU**

Lamps: Mercmaster LED, Class I, Division 2, Polycarbonate Optic

Candela Distribution						
	0.0	22.5	45.0	67.5	90.0	Flux
0	2208	2208	2208	2208	2208	
5	2202	2195	2197	2195	2202	209
15	2137	2131	2127	2131	2137	603
25	2045	2003	1977	2003	2045	926
35	1669	1658	1735	1658	1669	1051
45	1252	1282	1297	1282	1252	988
55	836	850	838	850	834	746
65	276	307	333	307	276	298
75	16	12	11	12	16	22
85	2	1	1	1	2	2
90	1	0	0	0	1	

Zonal Lumen Summary		
Zone	Lumens	% Fixture
0-30	1738	35.8
0-40	2789	57.5
0-60	4523	93.3
0-90	4844	99.9

CIE Type – Direct	
Plane	Spacing Criteria
0-Deg	90-Deg
1.2	1.2

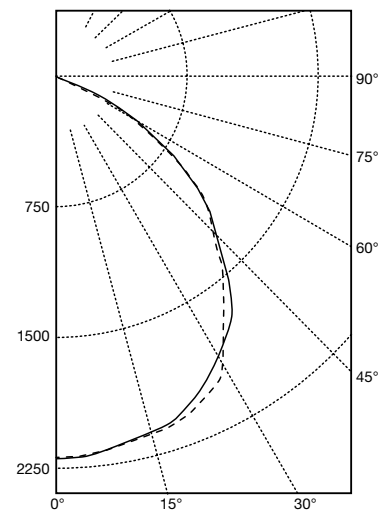

Appleton

LED/AREA: NEC/CEC, ATEX/IECEX ENCLOSED AND GASKETED

Mercmaster™ LED Series Luminaires

Enclosed and Gasketed Fixtures

NEC/CEC:

Class I, Division 2, Groups A, B, C, D
 Class I, Zone 2, AEx nA IIC
 Class II, Division 1, Group E, F, G
 Class II, Division 2, Group F, G
 Class III

NEC/CEC:

Type 3R, 4, 4X
 IP66/67
 Simultaneous Exposure
 Suitable for Use in Wet Locations
 Marine Outside Type (Salt Water)

ATEX/IECEX:

Zone 2 and 22
 II 2 GD
 IP66/67

Photometric Data – DATA SHOWN IS ABSOLUTE

REPORT NUMBER: **MLEDN17P5BU**

Lamps: Mercmaster LED, Class I, Division 2, Polycarbonate Optic

Candela Distribution

	0.0	22.5	45.0	67.5	90.0	Flux
0	2739	2739	2739	2739	2739	
5	2724	2724	2725	2724	2724	259
15	2660	2658	2655	2658	2660	752
25	2553	2508	2462	2508	2553	1156
35	2069	2062	2201	2062	2069	1312
45	1580	1614	1655	1614	1580	1243
55	1047	1093	1046	1093	1047	943
65	353	380	391	380	353	378
75	19	15	16	15	19	28
85	2	1	1	1	2	2
90	1	0	0	0	1	

Zonal Lumen Summary

Zone	Lumens	% Fixture
0-30	2167	35.7
0-40	3478	57.2
0-60	5664	93.2
0-90	6072	99.9

CIE Type – Direct

Plane	Spacing Criteria
0-Deg	90-Deg
1.2	1.2

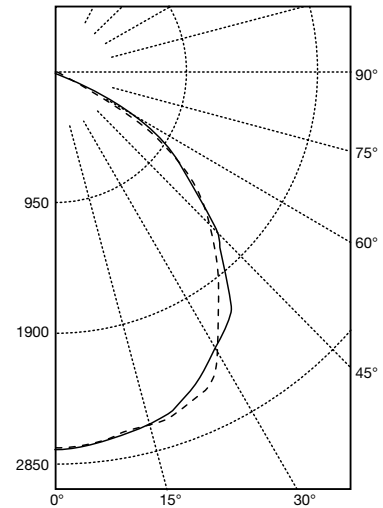

REPORT NUMBER: **MLEDN17P1BU (NEMA Type I)**

Lamps: Mercmaster LED, Class I, Division 2, Polycarbonate Optic

Candela Distribution

Zone	Lumen
0-10	546.35
10-20	1546.51
20-30	1410.19
30-40	1071.42
40-50	791.23
50-60	524.94
60-70	261.82
70-80	44.42
80-90	3.81

CIE Type – Direct

Plane	Spacing Criteria
0-Deg	90-Deg
0.84	0.84

Zonal Lumen Summary

Zone	Lumens	% Fixture
0-20	2092.86	33.70
0-30	3503.05	56.50
0-40	4574.48	73.70
0-60	5890.65	94.90
0-80	6196.88	99.90
0-90	6200.69	99.90

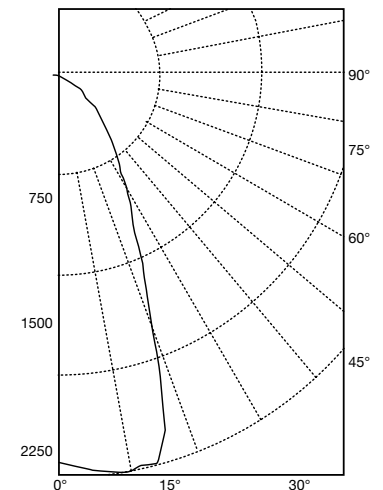

Appleton

LED/AREA: NEC/CEC, ATEX/IECEX ENCLOSED AND GASKETED

Mercmaster™ LED Series Luminaires

Enclosed and Gasketed Fixtures

NEC/CEC:

Class I, Division 2, Groups A, B, C, D
 Class I, Zone 2, AEx nA IIC
 Class II, Division 1, Group E, F, G
 Class II, Division 2, Group F, G
 Class III

NEC/CEC:

Type 3R, 4, 4X
 IP66/67
 Simultaneous Exposure
 Suitable for Use in Wet Locations
 Marine Outside Type (Salt Water)

ATEX/IECEX:

Zone 2 and 22
 II 2 GD
 IP66/67

Photometric Data – DATA SHOWN IS ABSOLUTE

REPORT NUMBER: **MLEDN250P5BU** ①

Lamps: Mercmaster LED, Class I, Division 2, Polycarbonate Optic

Candela Distribution						
	0.0	22.5	45.0	67.5	90.0	Flux
0	4206	4206	4206	4206	4206	
5	4170	4182	4177	4182	4170	397
15	4035	4046	4038	4046	4035	1145
25	3913	3888	3829	3888	3913	1784
35	3211	3233	3380	3233	3211	2046
45	2484	2524	2532	2524	2484	1942
55	1710	1763	1708	1763	1710	1530
65	682	564	606	564	682	568
75	20	18	17	18	20	31
85	2	1	1	1	2	2
90	1	1	0	1	1	

Zonal Lumen Summary		
Zone	Lumens	% Fixture
0-30	3326	35.2
0-40	5372	56.8
0-60	8844	93.5
0-90	9445	99.9

CIE Type – Direct	
Plane	Spacing Criteria
0-Deg	90-Deg
1.2	1.2

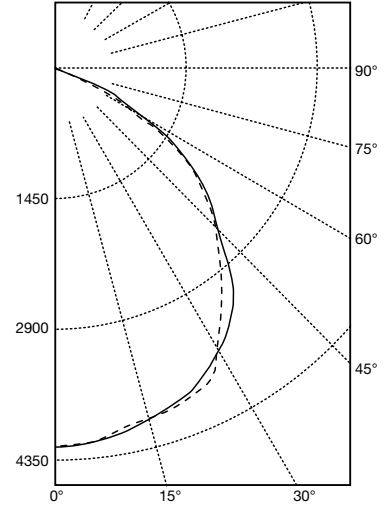

REPORT NUMBER: **MLEDN35P5BH** ①

Lamps: Mercmaster LED, Class I, Division 2, Polycarbonate Optic

Candela Distribution						
	0.0	22.5	45.0	67.5	90.0	Flux
0	4439	4439	4439	4439	4439	
5	4425	4417	4445	4432	4447	421
15	4356	4368	4410	4404	4418	1249
25	4356	4331	4394	4395	4357	20166
35	3912	3930	4045	4107	3826	2440
45	2929	2883	2866	2874	2929	2248
55	2277	2256	2296	2438	2394	2085
65	1105	893	843	957	825	927
75	20	25	22	26	22	38
85	2	2	2	4	3	4
90	1	1	1	2	1	

Zonal Lumen Summary		
Zone	Lumens	% Fixture
0-30	3686	32.3
0-40	6126	53.6
0-60	10460	91.5
0-90	11428	100.0

CIE Type – Direct	
Plane	Spacing Criteria
0-Deg	90-Deg
1.4	1.4

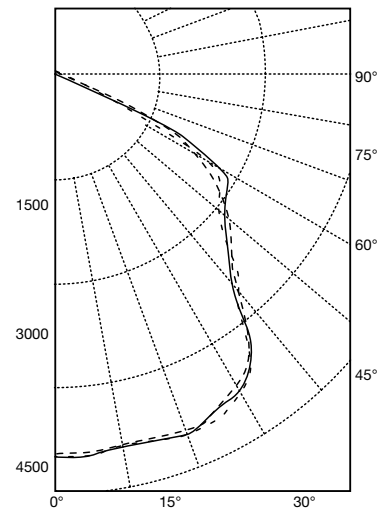

① Lamp type is not certified for use in ATEX/IEC governed locations.

Mercmaster™ LED Series Luminaires

Enclosed and Gasketed Fixtures

NEC/CEC:

Class I, Division 2, Groups A, B, C, D
 Class I, Zone 2, AEx nA IIC
 Class II, Division 1, Group E, F, G
 Class II, Division 2, Group F, G
 Class III

NEC/CEC:

Type 3R, 4, 4X
 IP66/67
 Simultaneous Exposure
 Suitable for Use in Wet Locations
 Marine Outside Type (Salt Water)

ATEX/IECEX:

Zone 2 and 22
 II 2 GD
 IP66/67

Photometric Data – DATA SHOWN IS ABSOLUTE

REPORT NUMBER: **MLEDN40P5BU**

Lamps: Mercmaster LED, Class I, Division 2, Polycarbonate Optic

Candela Distribution

	0.0	22.5	45.0	67.5	90.0	Flux
0	4958	4958	4958	4958	4958	
5	4976	4983	4949	4956	4941	472
15	4943	4934	4907	4921	4913	1400
25	4884	4920	4869	4900	4980	2263
35	4466	4590	4430	4410	4468	2738
45	3215	3213	3269	3286	3160	2525
55	2592	2635	2578	2612	2617	2330
65	833	1145	1070	1020	922	1067
75	30	32	29	33	32	55
85	40	5	3	3	3	5
90	1	2	1	1	1	

Zonal Lumen Summary

Zone	Lumens	% Fixture
0-30	4135	32.2
0-40	6873	53.5
0-60	11728	91.2
0-90	12855	100.0

CIE Type – Direct

Plane	Spacing Criteria
0-Deg	90-Deg
1.4	1.4

